

Veka N

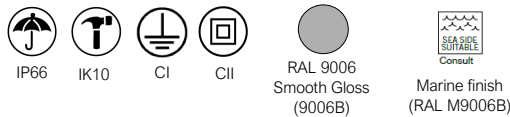

KEY BENEFITS

- Up to 5 fixations.
- Tool-free access from the top
- Durability and sturdiness: IP66 + IK10.
- Die Cast aluminium (Cu<0.1%).
- Energy Efficient:
GEN1: 150 lm/W.
GENA: 166 lm/W.
- Up to 17 optical distributions.
- Smart Ready: Designed to house both indoor and outdoor communication nodes.
- Future Proof: Zhaga-compliant.
- Lifetime L90B10 100.000h (T^a) 25°C.
- Night Friendly: ULR Arrêté du 27/12/2018.
- High speed Sensor capability.
- 5 years warranty.



Dark-Sky Association certification
 ≤ 3.000K not available for 4.000K.
 Mechanical adjustment: max. + or- 15 degrees to allow leveling in the field.



DESCRIPTION

Veka is the new luminaire family for public street lighting by Carandini. Its elegant design, latest generation LED technology and optical distributions make it a quality solution for urban streets, secondary roads, residential streets, car parks and bike lanes.



		Amber optic + 4000K	PC amber	2200K	2700K	3000K	4000K
U500	GEN1	<0,2%	<0,25%	<6%	<10%	<15%	< 22%
	GENA	-	-	-	-	12,36%	19,7%

STANDARDS / CERTIFICATES

- CE
- RoHS
- UNE-EN 60598-1
- UNE-EN 60598-2-3
- UNE-EN 62471
- UNE-EN 61000-3-2
- UNE-EN 61000-3-3
- UNE-EN 55015
- UNE-EN 61547
- UNE-EN 62031
- UNE-EN 61347-2-13
- UNE-EN 62384
- UNE-EN 13032-4
- UNE-EN ISO 9227 NSS: 2017 (1,000 h)

	GEN1: 487lm - 10.232lm GENA: 794m - 11.252m		PT: 0,03860m ² SE: 0,03256m ² FM: 0,03072m ² FT: 0,1m ²
	GEN1:150lm /W GENA: 166lm/W Luminaire		-40°C - +50°C
	5.3 Kg		0,0% FHS/ULR
	Tool-less access to control gear		

*Test reports from independent ENAC accredited laboratories or equivalent
 Measurements taken at ISO 17025 approved laboratory.
 Meets the minimum CEI - IDAE requirements.

220 - 240V / 100V - 277V
 50-60Hz
 L90B10 100,000 h
 Ta 25 °C

Distributor: EPK elektro s.r.o.
 info@carandini.cz - www.carandini.cz



PHOTOMETRIC DISTRIBUTIONS

It has the 9 photometric distributions used for the environments in which this type of luminaire is installed, allows it to adapt to all needs:

GEN1

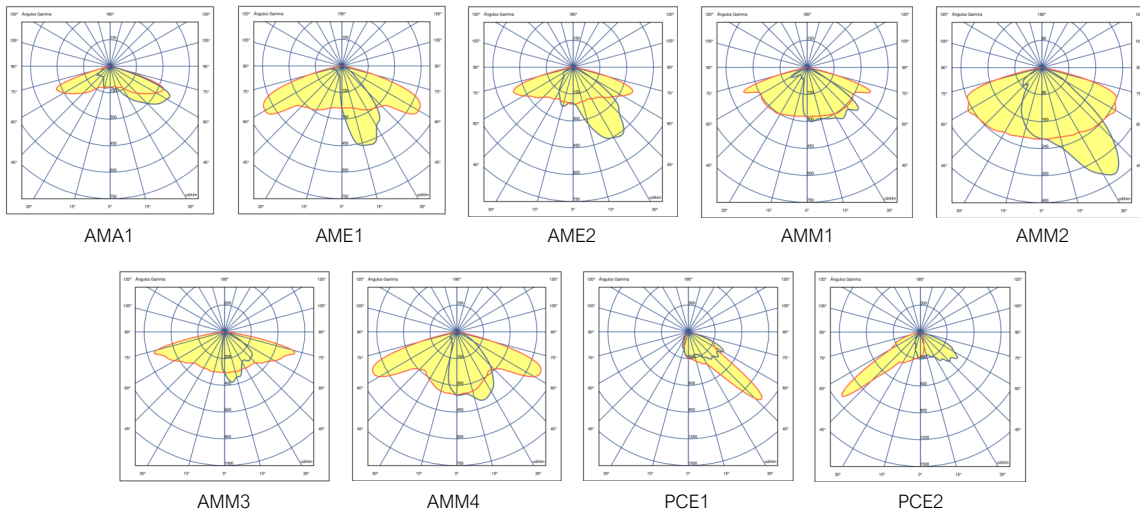

GENA

It has the 8 photometric distributions used for the environments in which this type of luminaire is installed, allows it to adapt to all needs:

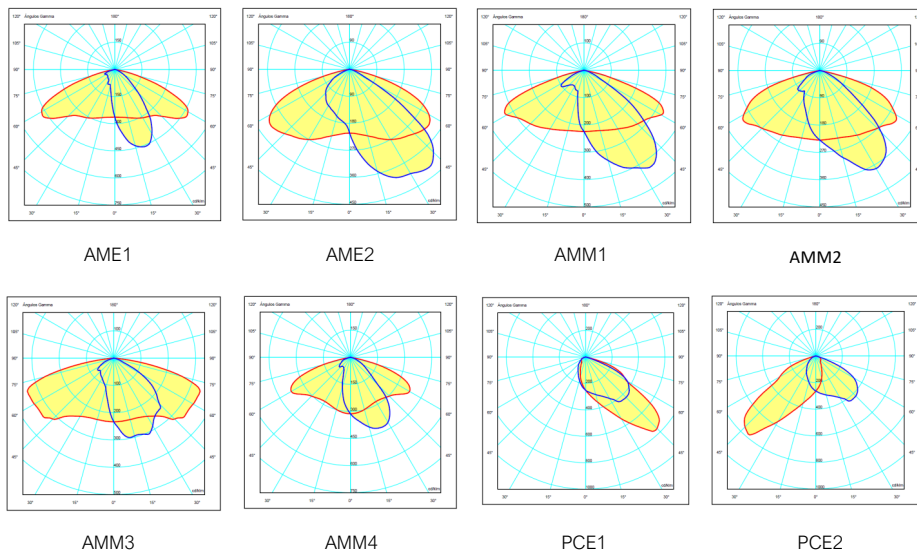

APPLICATIONS

Public streets, secondary roads, residential streets, car parks and bike lanes.



Distributor: EPK elektro s.r.o.
info@carandini.cz - www.carandini.cz

VEKA N CHARACTERISTICS

GENERAL INFORMATION

Sustainability	Valorisation: 99,38% Carbon footprint per use: 0,020461 kg kW/h de CO2
CE mark	Yes
ENEC Certificate	Yes
RoHS-compliant	Yes
Testing standards	LM 79-80 (all measurements at ISO17025 certified laboratory)

GENERAL CHARACTERISTICS

Body and mounting	Die cast aluminum EN AC-44100 with low copper content <0.1%.
Closure	Tempered glass 5mm
Nuts outer and bolts	Stainless steel (AISI304).
Watertightness	IP66 (EN 60598-1 and EN 60529)
Impact protection grade	IK10 (EN 62262)
Operating temperature	Ta -40 °C a +50 °C According to luminaire configuration.
Lifetime	L90B10 100,000h at Ta of 25°C. Light maintenance assessments to TM-21 based on LM-80 data.
Cable	Class I/II Cable from 4 to 8 metres Cross-section: 2x1.5 ; 3x1.5 ; 4x1.5 ; 5x1.5; 2x2.5; 3x2.5

ELECTRICAL CHARACTERISTICS

Electrical class	Class I o Class II
Voltage / Frequency	220V - 240V / 50Hz - 60Hz Optional 120V - 277V
Power factor	> 0,9
Harmonic distortion	< 10%
Surge protector	Surge protection (1.2 / 50) 10 kV. Maximum current (8/20) 10kA. Maximum voltage (L-N) 320 V. Maximum voltage (L / N-GND) 400 V. Optional overvoltage protection: 20kA, 20kV

LIGHTING CHARACTERISTICS

Real light package	GEN1: 487lm - 10.232lm (6 - 75W) GENA: 794m - 11.252lm (6 - 75W)
LED colour temperature	4,000K (Neutral White, nw). 3,000K (Warm White, ww). 2,700K (Warm White, ww). 2,200K (Warm White, ww). Amber
Index of reproduction chromatic (CRI)	CRI>70. CRI80 upon request.
LEDs	Includes 8, 16 and 24 LEDs.
FHS/ULR	0,0%
Optics	PMMA polymethylmethacrylate.
Photometric distributions	AMA1=> Throw 70° Spread 65° (Type IV) AME1=> Throw 65° Spread 15° (Type I) AME2=> Throw 70° Spread 35° (Type II) AMM1=> Throw 70° Spread 35°/50° (Type III) AMM2=> Throw 60° Spread 35° (Type II) AMM3=> Throw 75° Spread 5°/20° (Type III) AMM4=> Throw 65° Spread 20° (Type II) PCE1=> Throw 50° Spread 55°/60° (Type III) PCE2=> Throw 50° Spread 45°/55° (Type II)
LED thermal control	Heat dissipation by conduction through the specific design for this luminaire, since it has been specifically designed for LED technology. (Heatsink).

FINISHES

PREDEFINED COLOUR OF THE LUMINAIRE

 RAL 9006	Grey polyester powder coat paint RAL 9006 Smooth Gloss (9006B).
--	---

Corrosion protection

 SEA SIDE SUSTAINABLE	Marine Finish (1.000h) (Optional)
--	-----------------------------------

VEKA N CHARACTERISTICS

MAINTENANCE AND ASSEMBLY

Installation and maintenance	Tool-free luminaire access system designed by Carandini. Access to the driver from the top.
Installation	PT1: Vertical fixation \varnothing 76mm.* SE1: Lateral fixation \varnothing 34/42mm. SE2/PT2: Lateral / vertical fixation \varnothing 49/60mm. FM1: Wall fixation. Includes bracket for direct installation on wall. FT1: Ceiling fixation. Incorporates bracket for direct ceiling mounting. * The PT1 fixation shall be supplied horizontally mounted (SE) for sustainability. * The PT2 fixation shall be supplied horizontally mounted (SE) for sustainability. *The FT1 fixation will be supplied semi-assembled.
Mechanical adjustment	Vertical and lateral installations offers an angle of inclination range of $\pm 10^\circ$ every 2.5° . The bracket for wall installation offers a range of inclination of $\pm 40^\circ$ every 2.5° .
Equipped weight	PT1: 5,3 Kg SE1: 4,8 Kg / SE2: 5,1 Kg FM1: 5 Kg FT1: 6,0 Kg
Wind Surf.	PT: 0,03860m ² SE: 0,03256m ² FM: 0,03072m ² T: 0,1m ²
Pressure equalisation valve	The luminaire is fitted with a valve that compensates any interior pressure to prevent the build-up of condensation, thereby extending the lifespan of the components.
Optional QR	Optional QR label, with maintenance manual, main luminaire features for troubleshooting, and access to the management platform

MANAGEMENT AND CONTROL

Equipment	1N: 1 Level RC: Controller dimmed RD: DALI AF: 1 - 10 V RL: Pulse adjustable LED 2N: 2 Level SR: Smart Ready (D4i)
Autonomous regulation	Regulations programmed from the factory: 56: 50% of the 24: 00h at 6: 00h. 66: 60% of the 24: 00h at 6: 00h. 76: 70% of the 24: 00h at 6: 00h. SC: Programming according to client.
CLO regulation	Flow rate during the life of the product: 7: 70% luminous flux throughout the life of the luminaire. 8: 80% luminous flux throughout the life of the luminaire. 9: 90% luminous flux throughout the life of the luminaire.
Socket connection	3-U: NEMA 3 pin socket with/without IP66 cover. 5-V: NEMA 5 pin socket with/without IP66 cover. 7-W: NEMA 7 pin socket with/without IP66 cover. 4-X: Larger Zhaga socket with/without IP66 cover. O-Y: Smaller Zhaga socket with/without IP66 cover. P-Q: Smaller/larger Zhaga socket with/without IP66
Sensor	1: Photocell for NEMA 3, 5 and 7 pin socket (20 lux) 2: Photocell for larger Zhaga socket (20 lux) 3: Motion sensor for smaller Zhaga socket. 4: Photocell for larger Zhaga socket (20 lux) and motion sensor for smaller Zhaga socket.
Node	BS: Controlux Basic

To select the purchase reference, consult the configurator at www.carandini.cz

DIMENSIONS

Vertical fixation \varnothing 76 mm (PT1)

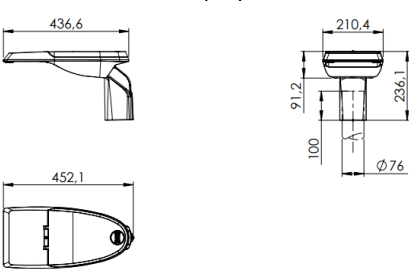

Lateral fixation \varnothing 34/42 mm (SE1)

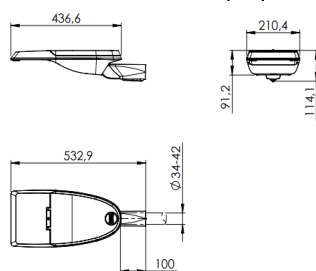

Wall fixation. Bracket included (FM1)

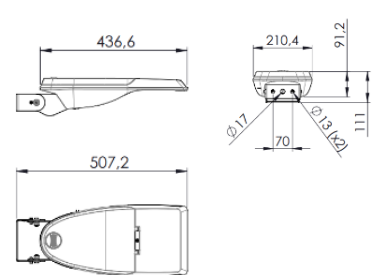

Lateral fixation \varnothing 49/60 mm (SE2)

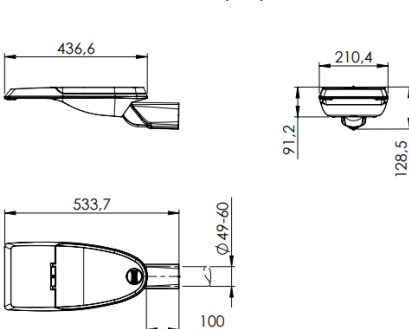

Vertical fixation \varnothing 49/60 mm (PT2)

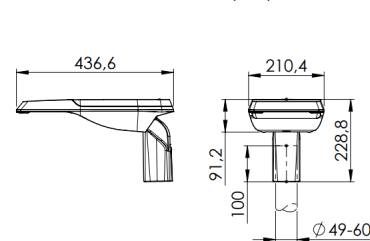

Ceiling fixation. Includes bracket for direct installation on wall. (FT1)

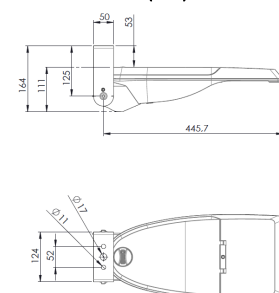

Distributor: EPK elektro s.r.o.
info@carandini.cz - www.carandini.cz

ACCESSORIES

Shield (consult)



VEKA N PHOTOGRAPHS



LOGISTICAL INFORMATION

European pallet

	VEKA N
Box dimensions	575 x 250 x 170 mm
Box weight:	5,6 kg.
Number of boxes:	48 units
Total dimensions	1200 x 800 x 1550 mm
Number of levels:	8 levels
Total gross weight:	289 kg.

NOTE: By sustainability reasons PT fixation accessories will be supplied assembled as side entry (SE)

NOTE: If the luminaire includes a cable, check box dimensions.

LUMINAIRE DIMMING

By programming the driver

Smart luminaires drivers can be programmed in the factory without needing a control system, additional wiring or maintenance costs. A schedule is pre-programmed for light flow to be automatically reduced at quieter times of the night while respecting light levels and uniformity.

Programming profile 56

From 00:00 to 06:00 the luminaire reduces its initial intensity by 50%.

Up to
26%
savings

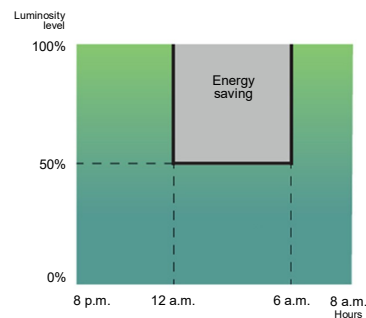

NOTE: Programming the Dynadimmer using the multitone scheduling tool is done for wintertime. In summer everything is delayed by an hour.

Using the CLO function

Taking into account lighting depreciation over the years, the driver is programmed to start at a reduced level and gradually increase power over the lifetime of the luminaire, which saves energy and increases the service life of the system. In addition, the level of illumination of the area in which it is located is always kept constant.

Constant luminous flux 8

Luminaire luminous flux at 80% to maintain light levels throughout its service life.

Luminous flux chart

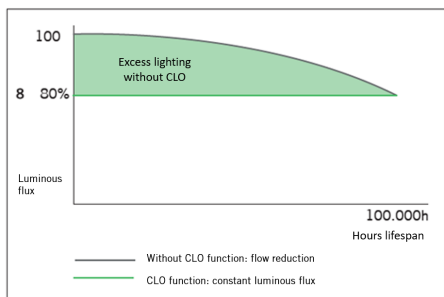

Consumption graph

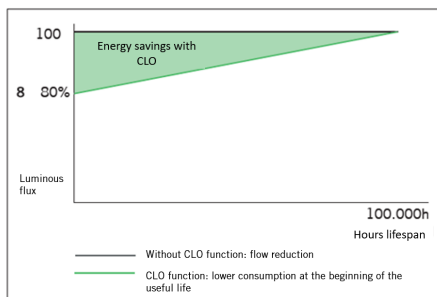

Up to
10%
savings
and increase in luminaire
service life

By adding an extra element

Photocell

The photocell allows the luminaire to be switched on or off depending on the intensity of the sunlight it captures.

This is very useful, to avoid having luminaires on at times when there is still enough natural light.

Example with 20 lx photocell:



INNOVATIVE AND UPDATABLE OVER TIME (Zhaga/ ZD4i)

"All luminaires incorporating Nema Sockets or Zhaga Sockets, where the control system is not the responsibility of Carandini, must always incorporate IP 66 covers in order to ensure the correct safety and operation of the product.

The sale of luminaires with Nema or Zhaga Sockets without the IP 66 cover will only be permitted upon receipt of a written assurance from the customer that the control system using NEMA or ZHAGA Nodes will be installed by the customer at the same time as the luminaires".



Zhaga - Future Proof

Zhaga is an industry-wide consortium that aims to standardise specifications for interfaces between LED luminaires and light sources. The aim is to achieve interchangeability between products made by different manufacturers. Zhaga defines test procedures for luminaire and LED light sources so that the luminaire can receive the LED source.



Zhaga D4i - Sensor Ready

The Zhaga consortium joined up with DiiA to create a unique Zhaga-D4i certification that combines Zhaga's Book 18 version 2 outdoor connectivity specifications with Dii4's D4i specifications for intra-luminaire DALI.

BOOKS PER APPLICATION. A COST-EFFECTIVE SOLUTION.



	Office & Industry	Retail & Hospitality	Outdoor
Integrated LED light engines	14, 2,8	17, 16	
LED modules (non-integrated)	7, 21, 14	12, 9, 5, 3,10	4, 15, 19
Drivers	13	LED set 22,23	24,25
Sensor and communication modules		20	18

The specifications that mark a component as Zhaga-compliant are contained in a series of books, available only to consortium members, that allow you to design to the marked standard. The benefits for society are evident since, apart from reducing the consumption of materials, it favours the reuse of luminaires, aiming towards a circular economy.

CERTIFICATION PROGRAMME

Zhaga-D4i certification covers all the essential characteristics, including automatic adjustment, digital communication, data reporting and power requirements in any single luminaire, ensuring plug-and-play interoperability for luminaires (drivers) and peripherals, such as connectivity nodes.

STANDARDISATION AS A MEANS TO ACHIEVE SUSTAINABILITY

The Veka N luminaire has been designed to function with the latest available market-proven technology based on standards. This also enables it to meet the CARANDINI sustainability requirements and become a product ready for maintenance in the future under better guarantees while respecting the environment and society.

The luminaires marked as Zhaga are a "Future Proof" design, meaning it is based on and designed around standard Zhaga components. These components are mainly the LED modules and the drivers. The electric compartment and dissipation area for LED modules has space and additional mountings to include any driver compliant with Zhaga "Book 13" based on market driver dimensions, or any LED module compliant with Zhaga "Book 15" based on LED controller interface specifications.

This makes it possible to have a sustainable product that can be updated over time.

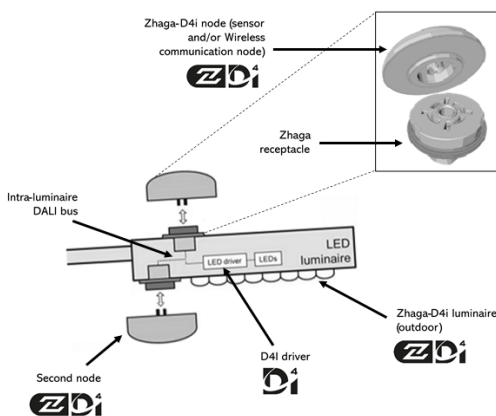

CONNECTIVITY

D4i specifications take the best of the standard DALI2 protocol and adapt it to an interconnected lighting environment, but with certain limitations. Only the control devices installed in the luminaires can be combined with a Zhaga-D4i luminaire. According to the specifications, the control devices are respectively limited to an average power consumption of 2W and 1W.

SMART CITY

Luminaires marked ZD4i are a "Smart Ready" design, which means they are designed to house both indoor and outdoor communication nodes through connection bases compliant with the Zhaga "Book 18" & Zhaga-D4i standard on sensor and communication node interoperability.